

LAY-Z-SPA.



AIRJET™ MASSAGE SYSTEM
 Système de massage Airjet™
 Sistema de masaje Airjet™
 Airjet™-Massagesystem
 Airjet™ - massage systeem
 Sistema di massaggio Airjet™
 System masujący Airjet™



NO TOOLS REQUIRED
 Aucun outil nécessaire
 No necesita herramientas
 Kein Werkzeug notwendig
 Geen gereedschap nodig
 Attrezzi non necessari
 Bez użycia narzędzi



SETUP TIME
 Temps de montage
 Tiempo de montaje
 Montagezeit
 Montagetijd
 Tempo di montaggio
 Czas montażu



FREEZE SHIELD™
 WINTERIZING SYSTEM

AIRJET™



ITEM · Article · Artículo · Artikel · Artikel · Prodotto · Artykuł

60015

180 x 180 x 66cm
 71" x 71" x 26"

TM LAY-Z-SPA™
 IBIZA AIRJET™

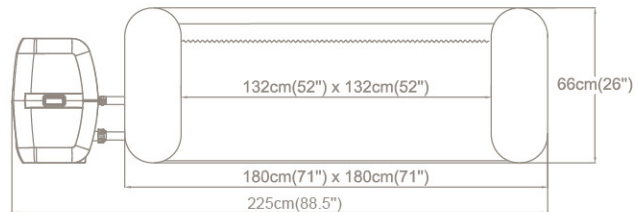
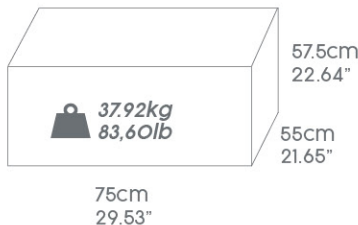

80%



MATERIAL · Matériel · Material · Material · Materiaal · Materiale · Material



FOAM BOTTOM
 Dessous mousse
 Parte inferior de espuma
 Schaumstoffboden
 Schuimbodem
 Fondo in schiuma
 Dno wykończone pianką



STURDY I-BEAM CONSTRUCTION
 Construction robuste I-Beam
 Estructura I-Beam resistente
 Stabile I-Beam Konstruktion
 Stevige I-Balk constructie
 Robusta costruzione I-Beam
 Przestronna konstrukcja I-Beam

KEY FEATURES · Caractéristiques · Características · Eigenschaften · Kenmerken · Caratteristiche · Cechy



WATER FILTRATION
 Filtration de l'eau
 Filtrado de agua
 Wasserfiltration
 Waterfiltratie
 Filtrazione
 Filtracja wody



MAXIMUM TEMPERATURE
 Température maximale
 Temperatura máxima
 Höchsttemperatur
 Maximum temperatuur
 Temperatura massima
 Temperatura maksymalna



HEATING
 Chauffage
 Calefacción
 Heizfunktion
 Verwarming
 Riscaldamento
 Ogrzewanie



POWER SAVING TIMER
 Minuterie d'économie d'énergie
 Temporizador de ahorro de energía
 Energiespar-Zeitschaltuhr
 Energiebesparende timer
 Timer risparmio energetico
 Energooszczędny timer

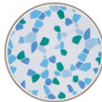

MOSAIC PRINTING
 Motif intérieur mosaïque
 Estampado interno de mosaico
 Innenverkleidung: mosaikoptik
 Mozaiek Print
 Stampa interna mosaico
 Nadruk wewnętrzny mozaika



DRAIN PIPE
 Vanne de drainage
 Tubo de desagüe
 Ablassrohr
 Afvoerpijp
 Tubo di scarico
 Rura spustowa

INCLUDES · Inclus · Incluye · Inhalt · Bevat · Include · Zawiera



60311

CARTRIDGE
 Cartouche
 Cartucho
 Kartusche
 Filter
 Cartuccia
 Wkład



INFLATABLE COVER
 Bâche gonflable
 Cubierta inflable
 Aufblasbare Abdeckung
 Opblaasbare afdekhoes
 Copertura gonfiabile
 Nadmuchiwana pokrywa



CHEMCONNECT™ DISPENSER
 Diffuseur ChemConnect™
 Dispensador ChemConnect™
 ChemConnect™ Chemikaliendosierer
 ChemConnect™ dispenser
 Galleggianti chimico ChemConnect™
 Dozownik ChemConnect™

Bestway

www.bestwaycorp.com



LAY-Z-SPA®

IBIZA AIRJET™

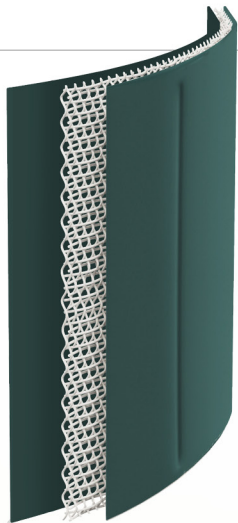
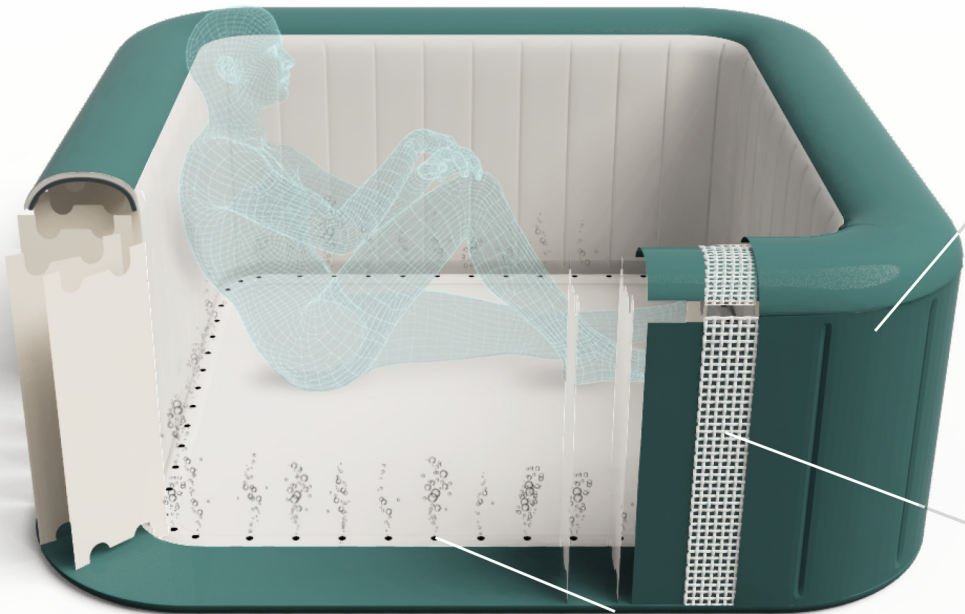

DURAPLUS™
Three layers
material ensures
higher **resistance**
and **stability**



Release of **air**
bubble from the
bottom of the spa



140
airjets



Warm
Air

INNOVATIONS, TECHNOLOGIES AND MATERIALS

Bestway

LAY-Z-SPA®

IBIZA

AIRJET™

MULTI FUNCTION PUMP

INTEGRATED
CUP HOLDER



SET THE
HEATER
TIMER



WATER FILTRATION
FUNCTION



HEATING
FUNCTION



MAX WATER
TEMPERATURE



INNOVATIONS, TECHNOLOGIES AND MATERIALS

Bestway



IBIZA AIRJET™

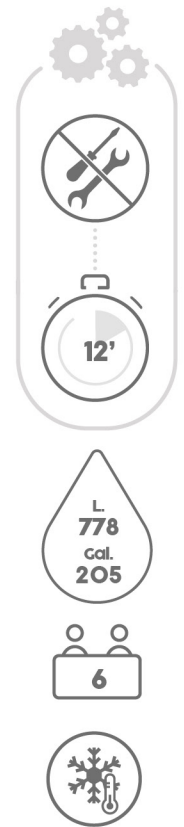
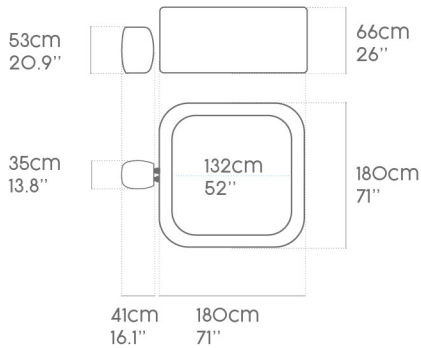

FREEZE SHIELD™
Equipped with an innovative winterizing technology for year-round, all weather use



INNOVATIONS, TECHNOLOGIES AND MATERIALS

Bestway